

# SOUND CARE™ *plus*

## INSTRUCTION MANUAL

**SoundCare™ Plus Pain Relief Device**  
Operating instructions  
Medical device for pain treatment  
based on ultrasound



## Contents

1. FOREWORD.....	3
2. SAFETY PRECAUTIONS.....	3
3. INDICATIONS AND CONTRAINDICATIONS.....	6
4. PRESENTATION.....	7
5. INSTALLATION.....	10
6. OPERATION.....	13
7. MAINTENANCE.....	15
8. DIAGNOSTICS.....	16
9. SPECIFICATIONS AND TECHNICAL DATA.....	17
10.STORAGE .....	18
11.DISPOSAL.....	18
12.STANDARDS AND REQUIREMENTS.....	19
13.GUIDANCE AND MANUFACTURER'S DECLARATION.....	19
14.WARRANTY.....	23
15.NORMALIZED SYMBOLS.....	24

## **1. FOREWORD**

### **1.1**

#### **General**

This manual has been written for the users of the ultrasound therapy SoundCare™ Plus. It contains general information on the operation, precautionary practices, and maintenance information. In order to maximize use, efficiency, and the life of the system, please read this manual thoroughly and become familiar with the controls, as well as the accessories before operating the system.

This user manual is published by Roscoe Medical, Inc.

Roscoe Medical, Inc. does not guarantee its contents and reserves the right to improve and amend it at any time without prior notice. Amendments will however be published in a new edition of this manual.

### **1.2**

#### **Therapy possibilities**

The ultrasound therapy SoundCare™ Plus is an apparatus featuring an ultrasound therapy unit. Pain affects the quality and enjoyment of life, especially for those who suffer chronic pain. SoundCare™ Plus is ultrasound therapy device for the treatment of chronic and acute muscular pain.

### **1.3**

#### **Treatment head**

The ultrasound treatment heads for the SoundCare™ Plus are so-called multi-frequency heads. This treatment head can now supply both 1 and 3MHz ultrasound. The head has excellent beam characteristics, fully meeting the requirements of the existing standards. The excellent beam characteristics, ergonomic design and effective contact control of the multi-frequency treatment heads make an optimal treatment possible. Standard accessories include a ultrasound head with 5cm<sup>2</sup> AER that can work at 1MHz and 3MHz. User can also choose to purchase ultrasound head with 1cm<sup>2</sup> AER that can also work at 1MHz and 3MHz.

### **1.4**

#### **Finally**

You have made a wise choice in selecting the SoundCare™ Plus. We are confident that your unit will continue to give satisfaction over many years of use. Nevertheless, if you have any inquiries or suggestions, please contact your authorized distributor.

## **2.**

### **SAFETY PRECAUTIONS**

#### **2.1**

#### **PRECAUTIONARY DEFINITIONS**

The precautionary instructions found in this section and throughout this manual are indicated by specific symbols. Understand these symbols and their definitions before operating this equipment. The definition of these symbols are as follows.



**Caution:** Text with a “CAUTION” indicator will explain possible safety infractions that could have the potential to cause minor to moderate injury or damage to equipment.



**Warning:** Text with a “WARNING” indicator will explain possible safety infractions that will potentially cause serious injury and equipment damage.



**Danger:** Text with a “DANGER” indicator will explain possible safety infractions that are imminently hazardous situations that would result in death or serious injury.

## 2.2 CAUTION



### **Caution:**

- Read, understand, and practice the precautionary and operating instructions. Know the limitations and hazards associated with using any ultrasound device. Observe the precautionary and operational decals placed on the unit.
- Keep yourself informed of the contraindications.
- Never leave the patient unattended during treatment.
- Do not operate the device when connected to any other medical devices.
- Do not operate this unit in an environment where other devices are used that intentionally radiates electromagnetic energy in an unshielded manner.
- Ultrasound should be routinely checked before each use to determine that all controls function normally, especially that the intensity control does properly adjust the intensity of the ultrasonic power output in a stable manner. Also, determine that the treatment time control does actually terminate ultrasonic power output when the timer reaches zero.
- Do not use sharp objects such as pencil point or ballpoint pen to operate the buttons on the control panel.
- Before each use, inspect Ultrasound Applicator for cracks, which may allow the ingress of conductive fluid.
- Inspect Applicator cables and associated connectors before each use. The ultrasound therapy control unit is not designed to prevent the ingress of water or liquids. Ingress of water or liquids could cause malfunction of internal components of system and therefore create risk of injury to the patient.
- Caution should be used for patients with suspected or diagnosed epilepsy.
- Refer to recent surgical procedures when muscle contraction may disrupt the healing process.
- Do not use over the menstruating or pregnant uterus, and over areas of the skin which lack normal sensation.
- SoundCare™ Plus should not be used when driving, operating machinery, or during any activity in which involuntary muscle contractions may put the user at undo risk of injury.

## 2.3 WARNING



### Warning

- To avoid the risk of electric shock, the SoundCare™ Plus must only be connected to a supply mains with protective earth.
- Care must be taken when operating this equipment around other equipment. Potential electromagnetic or other interference could occur to this device or to the other equipment. Try to minimize this interference by not using other equipment in conjunction with SoundCare™ Plus.
- The device may not be used in close proximity (i.e. less than 2 meters) to short-wave equipment.
- The device may not be used in so - called “wet rooms” (hydrotherapy rooms)
- The user must keep the device out of the reach of children.
- Only use the device for the recommended applications. The device should be used under medical supervision.
- Use of controls or adjustments to or performance of procedures other than those specified in the instruction manual may result in hazardous exposure to ultrasonic energy.
- Before administering any treatment to a patient you should become acquainted with the operating procedures for each mode of treatment available, as well as the indications, contraindications, warnings, and precautions. Consult other resources for additional information regarding the application of the Ultrasound.
- Do not use solvents to clean the device.
- A damaged device must no longer be used.
- The device must only be serviced, repaired and opened by authorized sales center.
- Dispose of the device in accordance with local regulations. Keep the operating instructions with the device.
- Pregnant and nursing women should use the device cautiously.
- Use the device cautiously when using it on immature bones.
- For continuous and effective treatment, the device should not be used more then 30 minutes per day.
- Do not use cellphone while the device is in operation.
- Use sensitive coupling glue cautiously.
- Always keep the sound head in constant motion.

## 2.4 Danger



### Danger

Patients with an implanted neurostimulation device must not be treated with or be in close proximity to any shortwave diathermy, microwave diathermy, therapeutic ultrasound diathermy, or laser diathermy anywhere on their body. Energy from diathermy (shortwave, microwave, ultrasound, and laser) can be transferred through the implanted neurostimulation system, can cause tissue damage, and can result in severe injury or death.

Injury, damage, or death can occur during diathermy therapy even if the implanted neurostimulation system is turned "off."

### **3. Indications and Contraindications**

#### **3.1 Indications**

- 1) Application of therapeutic deep heat can be used for the treatment of selected sub-chronic and chronic medical conditions such as:
  - Relief of pain, muscle spasms and joint contractures that may be associated with:
  - Adhesive capsulitis
  - Bursitis with slight calcification
  - Myositis
  - Soft tissue injuries
  - Shortened tendons due to past injuries and scar tissues
- 2) Relief of sub-chronic and chronic pain and joint contractures resulting from:
  - Capsular tightness
  - Capsular scarring
- 3) This device should be used in the hospital and home.
- 4) This device should be operated only by the experienced physician.

#### **3.2 Contraindications**

- This device should not be used for symptomatic local pain relief unless etiology is established or unless a pain syndrome has been diagnosed.
- This device should not be used when cancerous lesions are present in the treatment area.
- This device should not be used when open wounds are present in the treatment area.
- This device should not be used on patients suspected of carrying serious infectious disease and or disease where it is advisable, for general medical purposes, to suppress heat or fevers.
- This device should not be used over or near bone growth centers until bone growth is complete.
- This device should not be used over the thoracic area if the patient is using a cardiac pacemaker.
- This device should not be used over a healing fracture.
- This device should not be used over or applied to the eye.
- This device should not be used over a pregnant uterus.
- This device should not be used on ischemic tissues in individuals with vascular disease where the blood supply would be unable to follow the increase in metabolic demand and tissue necrosis might result.
- This device should not be used over tumors.

## 4. PRESENTATION

### 4.1 Presentation of the device

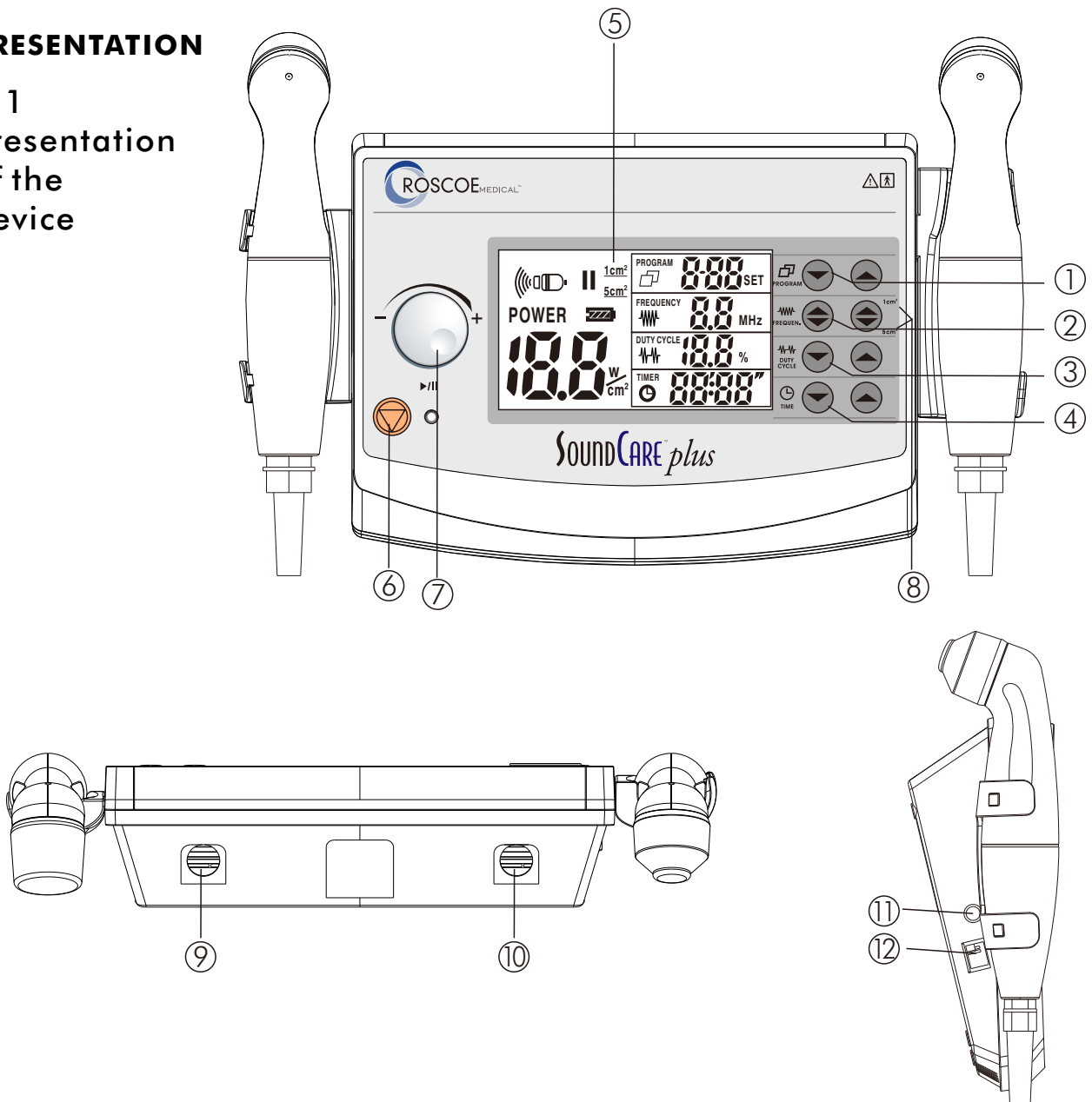

- 1) Program adjustment button
- 2) 1 MHz and 3 MHz adjustment button
- 3) Duty cycle adjustment button
- 4) Timer adjustment button
- 5) Liquid crystal display
- 6) Stop button
- 7) Output intensity adjustment knob and pause button
- 8) Treatment head select button
- 9) The socket of treatment head (5cm<sup>2</sup>)
- 10) The socket of treatment head (1cm<sup>2</sup>)
- 11) Adapter Receptacle
- 12) Power switch

4.2  
Liquid  
crystal  
display

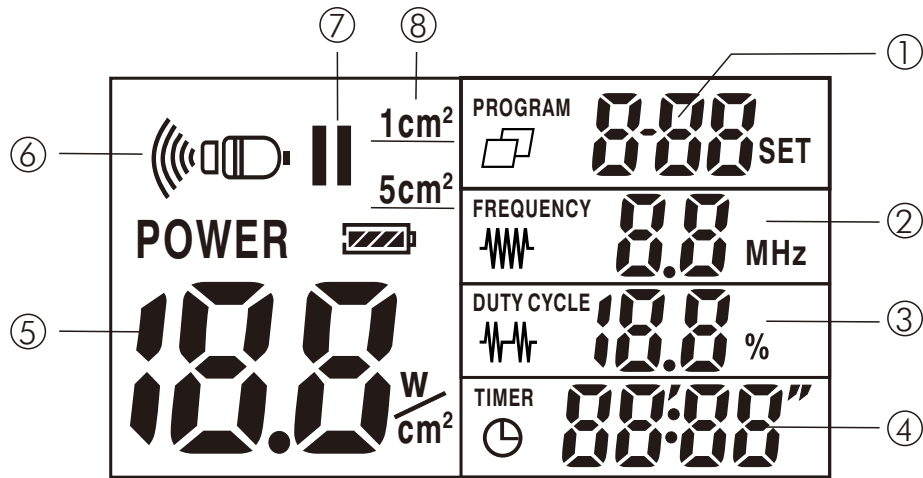

- |                         |                                |
|-------------------------|--------------------------------|
| 1) Program indicator    | 5) Output intensity/power      |
| 2) Frequency indicator  | 6) Ultrasound output indicator |
| 3) Duty cycle indicator | 7) Pause indicator             |
| 4) Timer indicator      | 8) Treatment head type         |

4.3  
Treatment  
head

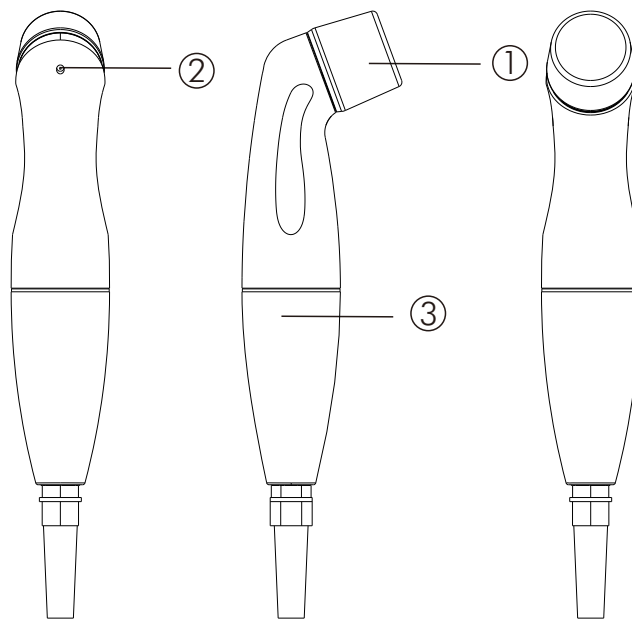











- 1) Sound head  
The component of the Applicator which makes contact with the patient during the Ultrasound therapy treatment of the time.
- 2) Applicator LED  
The component of the Applicator which indicates if the Sound head is working or Nonworking on the treatment area.
- 3) Applicator  
The assembly that connects to the System and incorporates the Sound Head.

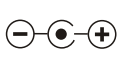

#### 4.4 Symbol definitions

Below are the definitions for all of the symbols used in the Ultrasound therapy device . Study and learn these symbols before any operation of the system.

	ON/OFF SWITCH
	STOP TREATMENT
	START / PAUSE BUTTON
	ULTRASOUND INTENSITY
	ULTRASOUND APPLICATOR STATE
	POLARITY OF POWER SUPPLY
	THE CONNECTION SOCKET OF TREATMENT HEAD
	PAUSE
	ULTRASOUND OUTPUT POWER
	ULTRASOUND OUTPUT INTENSITY
	TREATMENT TIME

#### 4.5 Key Function

ON/OFF Switch

- With this button the SoundCare™ Plus is turned on or off.

Pause Knob

- Pause/Restore treatment working

Intensity Knob

- Rotating the intensity control Knob to start treatment
- Set intensity by rotating the intensity control Knob to the prescribed level
- Clockwise-Increase Intensity  
Counterclockwise-Decreases Intensity

Escape button

- Stop treatment

UP and DOWN Arrows

- Controls used in various modality parameter screens to navigate or change a value up or down within the parameter.

**5.0  
INSTALLATION**

**5.1 Reception of equipment and accessories** Remove the Therapy System and all accessories from shipping cartons. Visually inspect for damage. Report any damage to the carrier. Your ultrasound therapy is supplied with case containing:

Part	Quantity
Ultrasound therapy unit	1
Ultrasound head with 5cm <sup>2</sup> AER	1
Ultrasound head with 1cm <sup>2</sup> AER	1
Adapter 1.35A to 100~240V	1
Lead for adapter	1
User manual	1

**5.2 Connection** Mains supply connections must comply with the national requirements regarding medical rooms. The equipment has a safety earth (ground) connection, and must be connected to an earthed (grounded) wall socket.

Prior to connection of this devices to the mains supply, check that the voltage and frequency stated on the type plate correspond with the available mains supply.

The main adapter is a part of the supply circuit on which the device's safety partly depends on. We recommend that you use the MPU50-160 type with of medical power. If you can not find the same type of medical power, please choose the same specifications (Output:DC15V/3A) medical power.

Connect the supplied mains adapter to the connector.

Connect the mains adapter to a wall socket.

 Caution: For your health, if you change the AC/DC adaptor, it must conform to the requirement of the standard medical electrical equipment.

**5.3 Connect the treatment head** Plug the applicator's connection plug into the corresponding socket connection on SoundCare™ Plus in accordance with the direction that marked at the applicator connector. If connected correctly, LCD will show the picture in Figure 1, if connection error, LCD will show the picture in Figure 2.

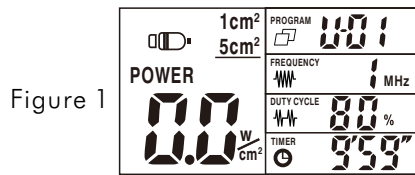

Figure 1

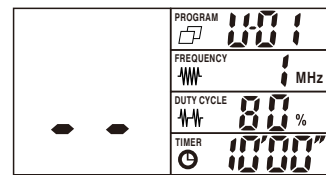

Figure 2



Caution: SoundCare™ Plus can only use the applicator that attached with main unit by the manufacturer. Please do not use other type of applicator.

**5.4 Switching on and self-test**

Switch on the device, using the power switch. Immediately after switching on, the device carries out a self-test. At the end of the self-test a beep is heard. When an error is found an error code will appear on the display. See section 8 for details.

**5.5 Therapy system set up**

SoundCare™ Plus has 10 kinds of treatment procedure models. Users can program their own operating parameters for treatment :

1. Ultrasonic frequency;
2. The treatment duty cycle;
3. Treatment time.

Operating parameters will be stored automatically ; and will not be lost when power is lost or upon shutdown.

**5.5.1 Choice/ Select therapy Program: U01-U10**

- Program Up key: Press this button to choose the program

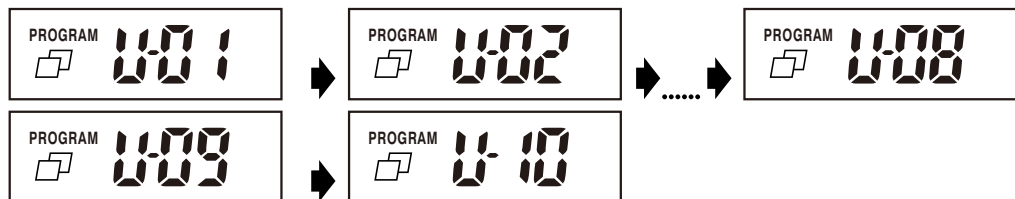

- Program Down key: Press this button to choose program

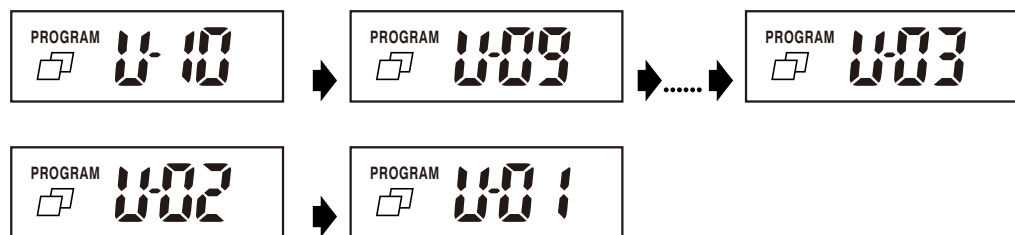

**5.5.2 Choice/ Select the Ultrasound Frequency: 1MHz or 3MHz**

- Freq Up key: Press this button to choose the Ultrasound Frequency



- Freq Down key: Press this button to choose the Ultrasound Frequency



**5.5.3  
Choice/  
Select the  
treatment  
head 1cm<sup>2</sup>  
or 5cm<sup>2</sup>**

- Select the treatment head 1cm<sup>2</sup> or 5cm<sup>2</sup> by pressing the treatment head select button.

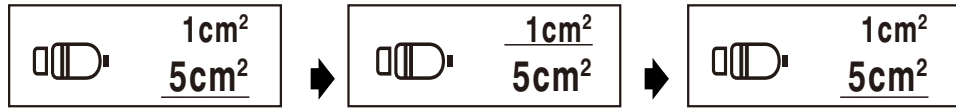

CAUTION: The user can select the treatment head 1cm<sup>2</sup> or 5cm<sup>2</sup> by pressing the treatment head select button when the two types of treatment head have been connected with the device. The device can default to select the treatment head automatically when only one treatment head is connected to the device.

**5.5.4  
Choice/  
Select the  
duty cycle:  
10%-100%,  
stepping  
10%**

- Duty Up key: Press this button to increase the duty cycle

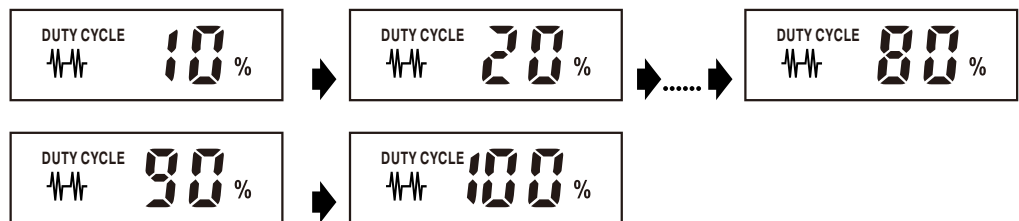

- Duty Down key: Press this button to decrease the duty cycle

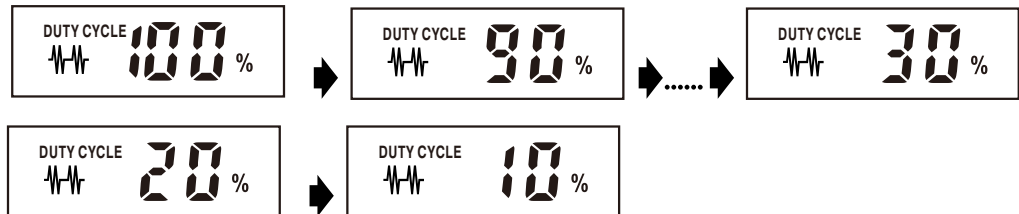

**5.5.5  
Setting  
the  
treatment  
time: 1  
min-30min,  
stepping  
1 min**

- Time Up key: Press this button to increase the treatment time

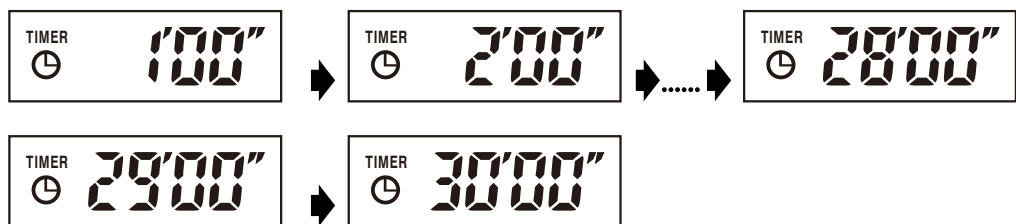

- Time Down key: Press this button to decrease the treatment time

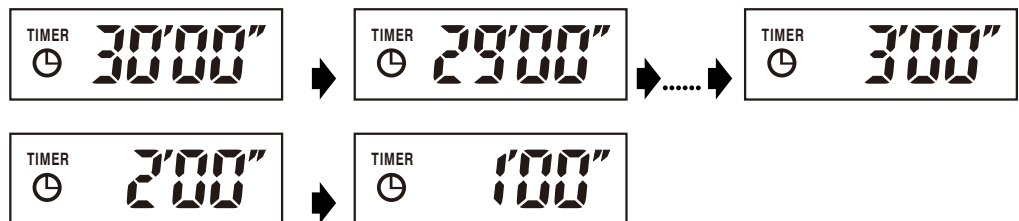

## 5.6 Disconn- ecting from the mains

Switch off the SoundCare™ Plus, by pressing the main switch.  
Pull out the main plug of the mains adapter from the adapter Receptacle.

## 6. OPERATION

### 6.1 Measures with regard to treatments

#### 6.1.1 Before the treatment

- Put the patient in a comfortable position. The area to be treated should be properly supported and exposed and perfectly relaxed.
- Inform the patient on the purpose of the treatment and the sensation he will perceive in the course of the therapy.
- Ensure there are no contraindications to treatment.
- Inspect the patient's skin accurately for any abrasions, inflammation, surface veins, etc.
- Clean the area to be treated with 70% alcohol or soap.
- It is advisable to shave areas of excessive hair-growth.

#### 6.1.2 During the treatment

- The treatment-head has to be moved constantly in a slow tempo, also in case of the semi-statically method.
- Ask the patient regularly about his/her experiences. If necessary, the treatment can be adjusted. By using knob [7], the intensity can be reduced.
- In case of indications of poor transmission of ultrasound energy, it is advised to add the contact-gel or reposition the ultrasound-head.
- During the treatment, if the ultrasonic applicator is connected well, the applicator LED will light; if the ultrasonic applicator doesn't contact well, the applicator LED will blink slowly, the system will be think this is no-load in the applicator. When treatment is paused, the applicator LED light will be extinguished. And the countdown will also be suspended.



#### **Caution**

The massage performed with the head should be applied with regular movement, not too slow to avoid inducing heat, nor too fast to prevent a bad contact which would reduce the effectiveness of the treatment.



### **Warning**

If you want to replace the treatment head, you need to turn the power switch off, so that the device is in shutdown state in order to replace the treatment head.

#### **6.1.3 After the treatment**

- Clean the treatment area well before treatment as well as the treatment -head by using a towel or a tissue.
- The treatment-head should be cleaned with a 70% alcohol solution.
- Check if there are any signs of improvement (e.g. pain, circulation and mobility).
- When entering the next treatment-session, the patient is instructed to report any possible reaction.

## **6.2 Operating the device**

### **6.2.1 Switch on the device**

Turn the device on using the On/Off . switch. The device executes a self-test; checking all important functions and presents itself with the start up settings. The start up settings is adjustable at memory location. To personalize the start up settings, refer to chapter 5.5, Therapy system set up.

### **6.2.2 Adjusting parameters**

Press the buttons [1], [2], [3], [4] to select a parameter.

### **6.2.3 Ultrasound intensity**

The ultrasound intensity is adjusted with intensity control knob. The ultrasound intensity can only be adjusted during treatment. The ultrasound intensity can be displayed in W or W/cm<sup>2</sup>. (Press the buttons [1], [2], [3], [4],[8] can change the displayed W or W/cm<sup>2</sup>)

### **6.2.4 Pause**

Press the knob [7] to pause the treatment. Press the knob [7] again to restore the treatment.

### **6.2.5 Emergency stop**

Pressing button [6] simultaneously will terminate all active treatments.

## **6.3 The treatment head**

A treatment head is a precision instrument. Great care is taken in the development and production in order to obtain the best possible beam characteristics. Rough treatment (jarring or dropping) can adversely affect these characteristics, and must therefore be avoided.

## 6.4 The contact medium

In order to ensure efficient transfer of energy, a contact medium is required between the treatment head and the body. Air causes virtually total reflection of the ultrasound energy. The best medium for the transfer of ultrasound energy is a gel.

- Liberally apply transmission gel to the treatment area on the patient.
- Move the treatment head during therapy session in a circular motion. The area treated should be two times the diameter of the treatment head.
- If the body surface is very irregular, making it difficult to obtain good contact between the treatment head and the body, or if direct contact must be avoided (e.g. due to pain), the affected area may be treated under water (subaquatic method). The water should be degassed (by previous boiling) in order to prevent air bubbles arising on the treatment head and body.



**Caution:** Never apply the gel to the treatment head. The treatment head will register this as contact and may emit ultrasound energy, which could damage the treatment head.

Always use gel with the requirements for medical use, such as with CE mark, or are legally marketed in the US.

## 7. MAINTENANCE

### 7.1 Cleaning of the device

Switch off the device and disconnect it from the mains supply. The device can be cleaned with a damp cloth. Use lukewarm water and a non-abrasive liquid household cleaner (no abrasive, no alcohol content solution). If a more sterile cleaning is needed, use a cloth moistened with an antimicrobial cleaner.



**Caution:** Do not submerge the device in liquids. Should the device accidentally become submerged, contact the dealer or Authorized Service center immediately. Do not attempt to use the system that has been immersed in liquid until inspected and tested by a Service Technician Certified by an Authorized Service center. Do not allow liquids to enter the ventilation holes in the optional modules. This could permanently damage the modules.

**7.2  
Cleaning  
of the  
treatment  
heads**

The treatment heads and cables should be regularly inspected for damage, e.g. hairline cracks, which could allow penetration by liquids. Clean the contact surface immediately after each treatment. Make sure that no ultrasound gel remains on the treatment head. We further recommend cleaning the head and cable daily, using lukewarm water. The treatment heads can be disinfected using a cloth moistened with 70% alcohol.

**7.3  
Maintenance**

- Maintenance and all repairs should only be conducted by the dealer agency. The manufacturer will not be held responsible for the results of maintenance or repairs completed by unauthorized persons.
- The service and or maintenance must be carried out by conform to the procedure described in the manual of the apparatus.
- Opening of the device by unauthorized agencies is not allowed and will terminate any claim to warranty.

**8.  
Diagnostics**

**8.1  
Displays  
fail to light  
up**

Check to see if the main adapter is connected to the device and the main supply.

**8.2 Error**

The device has discovered a fault during or after the self-test. The error displays the following figure 3. Remove any applicators or cables from the output sockets and switch the device off and on again. If the code re-appears, contact your supplier. The device is probably defective.

**Figure 3**

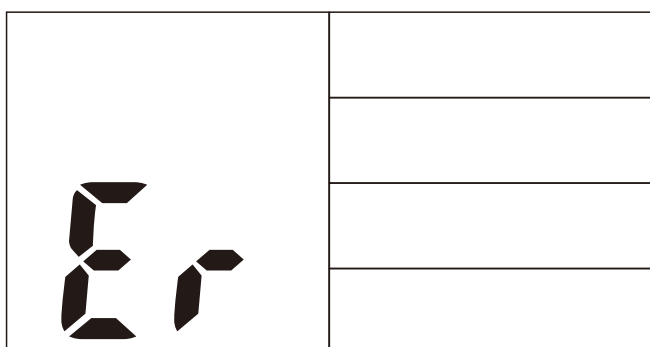



**8.3**  
The contact control fails to operate

Check the connected plug of ultrasound applicator.

Figure 4

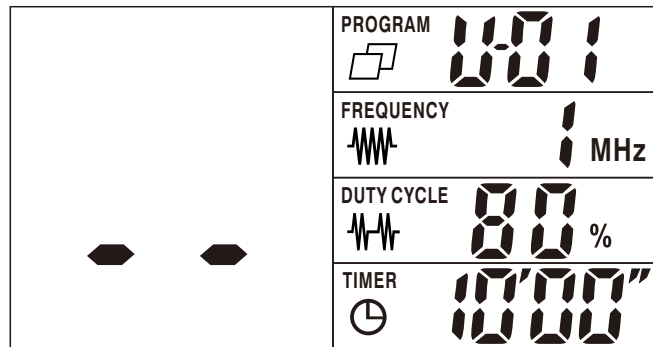

**9.**  
**SPECIFICATIONS**  
**AND TECHNICAL**  
**DATA**

**9.1**  
**Electrical**  
**data**

Technical data of device

Acoustic Frequency:	1MHz±10%,3MHz±10%
Output Power:	0.5W-10.0W±20%,when duty factor≥80% for 5cm <sup>2</sup> 0.5W-15.0W±20%,when duty factor≤70% for 5cm <sup>2</sup> 0.1W-2.0W±20%, when duty factor≥80% for 1cm <sup>2</sup> 0.1W-3.0W±20%, when duty factor≤70% for 1cm <sup>2</sup>
Pulse repetition rate:	100Hz±10%
Duty factor :	10%-100%,Stepping 10%
Timer:	Max 30 minutes
Effective radiating area (A <sub>ER</sub> )	5.0cm <sup>2</sup> ±20%; 1.0cm <sup>2</sup> ±20%
Effective intensity (Max.)	3.0W/cm <sup>2</sup> ±20%(1MHz), 3.0W/cm <sup>2</sup> ±20%(3MHz)
R <sub>BN</sub> (Max):	5.0
Beam type:	Collimated
Material of applicator:	Aluminium
Classification of protection against electric shock	Class I medical equipment
Classification of applied part	Type BF
Waterpro of Grade	IPX7 Only for treatment head

Technical data of power supply

Adapter supply voltage:	100V-240V, 47Hz-63Hz, 1.35A
Adapter output:	15V=3A Max.
Dimensions:	143mm(L)x73mm(W)x40mm(H)

Environmental conditions for use

Environment temperature:	10-40°C
Relative humidity:	30%-85%
Atmospheric pressure:	800-1060hPa

Environmental conditions for storage

Environment temperature:	-10°C-55°C
Relative humidity:	10%-90%
Atmospheric pressure:	700-1060hPa

**9.2  
Program  
List Table**

Program	Frequency	Duty Cycle	Treatment Time	Suggest Intensity
U-01	1MHz	80%	10 minutes	1.0W/cm <sup>2</sup>
U-02	1MHz	50%	10 minutes	1.0W/cm <sup>2</sup>
U-03	1MHz	50%	20 minutes	1.5W/cm <sup>2</sup>
U-04	1MHz	50%	15 minutes	1.0W/cm <sup>2</sup> 1.5W/cm <sup>2</sup> 2.0W/cm <sup>2</sup>
U-05	3MHz	80%	15 minutes	1.0W/cm <sup>2</sup>
U-06	1MHz	30%	15 minutes	1.5W/cm <sup>2</sup>
U-07	1MHz	80%	15 minutes	1.0W/cm <sup>2</sup> 1.5W/cm <sup>2</sup>
U-08	1MHz	80%	8 minutes	1.5W/cm <sup>2</sup>
U-09	1MHz	50%	12 minute	1.5W/cm <sup>2</sup>
U-10	3MHz	80%	10 minutes	1.0W/cm <sup>2</sup>

**10.  
STORAGE**

For a prolonged pause in treatment, store the device with the adapter in a dry room and protect it against heat, sunshine and moisture.

Store the machine in a cool, well-ventilated place.

Never place any heavy objects on the machine.

**11.  
DISPOSAL**



Please dispose of the device in accordance with the directive 2002/96/EC WEEE (Waste Electrical and Electronic Equipment). If you have any questions, please refer to the local authorities responsible for waste disposal.

**12.  
STANDARDS  
AND  
REQUIREMENTS**

Roscoe Medical, Inc. declares that the device complies with following normative documents:  
IEC/EN60601-1, IEC/EN60601-1-2, IEC/EN60601-2-5,  
IEC/EN61689, IEC60601-1-4, IEC62304, ISO10993-5,  
ISO10993-10, ISO10993-1, ISO14971.

**13.  
GUIDANCE  
AND  
MANUFACTURER'S  
DECLARATION**

**13.1  
Declaration-  
electro-  
magnetic  
emissions**

Guidance and manufacturer's declaration - electromagnetic emissions		
The SoundCare™ Plus device is intended for use in the electromagnetic environment specified below. The customer or the user of the SoundCare™ Plus should assures that it is used in such an environment.		
Emissions test	Compliance	Electromagnetic environment - guidance
RF emissions CISPR 11	Group 1	The SoundCare™ Plus device uses RF energy only for its internal function. Therefore, its RF emissions are very low and are not likely to cause any interference in nearby electronic equipment.
RF emissions CISPR11	Class B	The SoundCare™ Plus device is suitable for use in all establishments including domestic and those directly connected to the public low-voltage power supply network that supplies buildings used for domestic purposes.
Harmonic emissions IEC 61000-3-2	Not applicable	
Voltage fluctuations / flicker emissions IEC 61000-3-3	Not applicable	

**13.2  
Declaration -  
electromagnetic  
immunity**

Guidance and manufacturer's declaration-electromagnetic immunity			
The SoundCare™ Plus device is intended for use in the electromagnetic environment specified below. The customer or the user of the SoundCare™ Plus should assure that it is used in such an environment.			
Immunity test	IEC 60601 test level	Compliance level	Electromagnetic environment - guidance
Electrostatic discharge (ESD) IEC 61000-4-2	±6 kV contact ±8 kV air	±6 kV contact ±8 kV air	Floors should be wood, concrete or ceramic tile. If floors are covered with synthetic material, the relative humidity should be at least 30 %.

**13.3  
Declaration-  
electromagnetic  
immunity**

Guidance and- manufacturer's declaration. Electromagnetic immunity			
The SoundCare™ Plus device is intended for use in the electromagnetic environment specified below. The customer or the user of the SoundCare™ Plus should assure that it is used in such an environment.			
Immunity test	IEC 60601 test level	Compliance level	Electromagnetic environment - guidance
Conducted RF IEC 61000-4-6 Radiated RF IEC 61000-4-3	3 Vrms 150 kHz to 80 MHz 3 V/m 80 MHz to 2.5 GHz	3 Vrms  3 V <sub>rm</sub>	Portable and mobile RF communications equipment should be used no closer to any part of the SoundCare™ Plus device, including cables, than the recommended separation distance calculated from the equation applicable to the frequency of the transmitter. Recommended separation distance.  $d = 1.2\sqrt{P}$ $d = 1.2\sqrt{P}$ 80MHz to 800MHz $d = 2.3\sqrt{P}$ 80MHz to 2.5MHz

			<p>where <math>P</math> is the maximum output power rating of the transmitter in watts (W) according to the Transmitter manufacturer and <math>d</math> is the recommended separation distance in meters (m).                  Field strengths from fixed RF transmitters, as determined by an electromagnetic site survey,<sup>a</sup> should be less than the compliance level in each frequency range.<sup>b</sup> Interference may occur in the vicinity of equipment marked with the following.</p> 
<p>NOTE 1 At 80 MHz ends 800 MHz the higher frequency range applies.                  NOTE 2 These guidelines may not apply in all situations. Electromagnetic propagation is affected by absorption and reflection from structures, objects and people.</p> <p>a. Field strengths from fixed transmitters, such as base stations for radio (cellular / cordless) telephones and land mobile radios, amateur radio, AM and FM radio broadcast and TV broadcast cannot be predicted theoretically with accuracy. To assess the electromagnetic environment due to fixed RF transmitters, an electromagnetic site survey should be considered. If the measured field strength in the location in which the SoundCare™ Plus device is used exceeds the applicable RF compliance level above, should be observed to verify normal operation. If abnormal performance is observed, additional measures may be necessary, such as reorienting or relocating the SoundCare™ Plus.</p> <p>b. Over the frequency range 150 kHz to 80 MHz, field strengths should be less than <math>[V_i]</math> V/m.</p>			

**13.4  
Recommended  
separation  
distances  
between  
portable  
and mobile**

RF communications equipment and the SoundCare™ Plus device

Recommended separation distances between portable and mobile RF communications equipment and the SoundCare™ Plus device			
The SoundCare™ Plus device is intended for use in an electromagnetic environment in which radiated RF disturbances are controlled. The customer or the user of the SoundCare™ Plus device can help prevent electromagnetic interference by maintaining a minimum distance between portable and mobile RF communications equipment (transmitters) and the SoundCare™ Plus as recommended below, according to the maximum output power of the communications equipment.			
Rated maximum output power of transmitter W	Separation distance according to frequency of transmitter m		
	150 kHz to 80 MHz $d=1.2\sqrt{P}$	80 MHz to 800 MHz $d=1.2\sqrt{P}$	800 MHz to 2,5 GHz $d=2.3\sqrt{P}$
0,01	0.12	0.12	0.23
0,1	0.38	0.38	0.73
1	1.2	1.2	2.3
10	3.8	3.8	7.3
100	12	12	23
For transmitters rated at a maximum output power not listed above, the recommended separation distance $d$ in meters (m) can be estimated using the equation applicable to the frequency of the transmitter, where $P$ is the maximum output power rating of the transmitter in watts (W) accordable to the transmitter manufacturer. NOTE 1 At 80 MHz and 800 MHz the separation distance for the higher frequency range applies. NOTE 2 These guidelines may not apply in all situations. Electromagnetic propagation is affected by absorption and reflection from structures, objects and people.			

**14.**  
**WARRANTY**

Please contact your dealer or the device centre in case of a claim under the warranty. If you have to send in the device, enclose a copy of your receipt and state what the defect is.

A. The following warranty terms apply:

- The warranty period for SoundCare™ Plus products is one year from date of purchase. In case of a warranty claim, the date of purchase has to be proven by means of the sales receipt or invoice.
- Defects in material or workmanship will be removed free of charge with in the warranty period.
- Repairs under warranty do not extend the warranty period either for the device or for the replacement parts.

B. The following is excluded under the warranty:

- All damage which has arisen due to improper treatment, e.g. nonobservance of the user instruction.
- All damage which is due to repairs or tampering by the customer or unauthorized third parties.
- Damage which has arisen during transport from the manufacturer to the consumer or during transport to the service centre.
- Accessories which are subject to normal wear and tear.
- Liability for direct or indirect consequential losses caused by the unit is excluded even if the damage to the unit is accepted as a warranty claim.

**15.  
NORMALIZED  
SYMBOLS**



The name and the address of the manufacturer



Type BF Applied Part



Serial Number of product



Batch code



Please attention to adjust the effective intensity



Disposal in accordance with Directive 2002/96/EC (WEEE)

**IPX7**

Only for treatment head: Protected against the effects of temporary immersion water



Complies with the European Medical Device Directive (93/42/EEC) and amended by directive 2007/47/EC requirements. Notified body TÜV Rheinland (CE0197)

**CB**

The electrical safety meet the CB system requirements



Indoor use only



Risk of electric shock



Complies with the safety requirements of Canada and U.S. The certification body is UL, the certificate number is E230351



Refer to Instruction Manual.











Manufacturer for Roscoe Medical, Inc.  
21973 Commerce Parkway, Strongsville, Ohio 44149  
[www.roscoemedical.com](http://www.roscoemedical.com)

